

Assembly Instruction

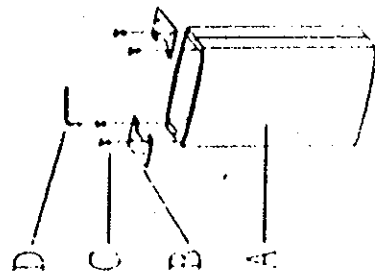

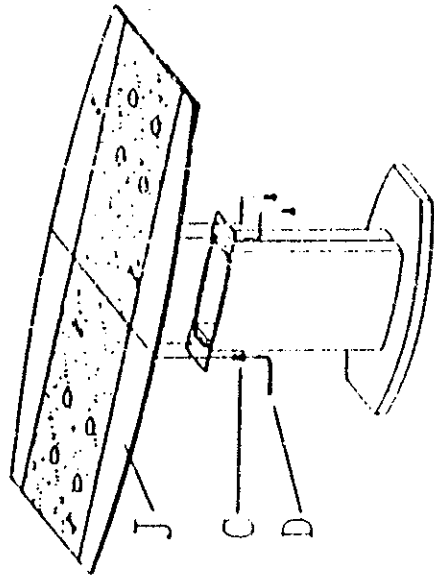





STEP 1

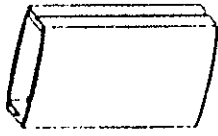

STEP 3

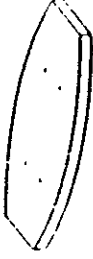

AD-8044DT

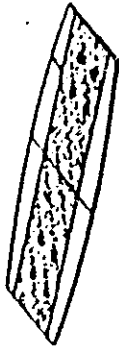
NO.	Description	Q.T.Y
A		1
B		2
C		8
D		1
E		1
F		4
G		4
H		4
I		1
J		1

STEP 2

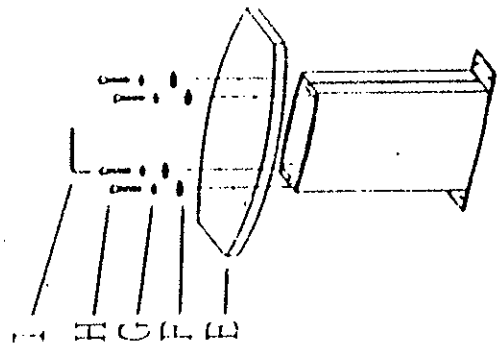

FINISHED

